

UHF RFID Handheld Reader

902~928MHz 1W

Model: WS-LOOKID

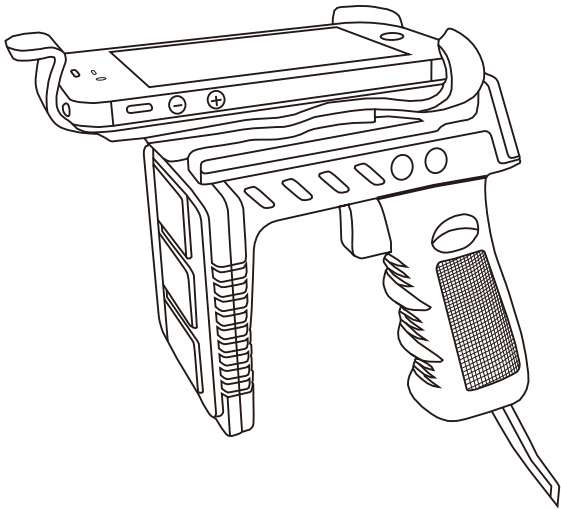

CCAB14LP3710T3

Instruction manual

Content

| | |
|--|----|
| Important event | 1 |
| Declaration | 1 |
| Warranty | 1 |
| Configuration Guide | 2 |
| Specification | 3 |
| Operating instruction | 4 |
| Turn on/off | 4 |
| OLED display | 4 |
| Switch mode | 5 |
| Bluetooth Mode | 5 |
| Micro SD Mode | 6 |
| Wi-Fi Mode | 6 |
| WIFI Configuration Process | 7 |
| AP Mode | 7 |
| Sta Mode | 11 |
| Set up two ways in Sta mode | 13 |
| A. VIA SERVER | 13 |
| B. VIA CLIENT | 15 |
| Reset the Wi-Fi settings | 17 |
| Adjust reading range | 17 |
| Switch the function | 18 |
| Delate micro SD file | 19 |
| Searching | 20 |
| Format of reading data | 21 |
| Searching mode | 22 |
| Install holder | 23 |
| CE Caution Note (European Union) | 24 |
| Administrative Regulations on Low Power Radio Waves Radiated Devices | 24 |
| FCC Consistent Declaration (U.S.A. Only) | 25 |

Important event

- ▶ This product is in general use for the equipment on the premise of the development, design, manufacture. Do not use that require high security purposes, such as machinery or medical, aviation equipment, machinery and transport-related deaths are directly or indirectly related to the system.
- ▶ This product should be in this brochure by the instructions of the types and rated voltage power under the current proper use. If violation of this statement by the safety records of the supply operation, I am afraid our company cannot afford any of the responsibility.
- ▶ Do not self-decomposition, alteration, repair of the products also will cause fire, electric shock, fault, and dangerous. In addition, their decomposition, alteration, and repair the product, failure is not within the scope of warranty.
- ▶ The products are not waterproof, so please do not use and touch water. Take off and on also please note. Rain, spray, drinks, steam, sweat may be a failure.
- ▶ Use of this product, please be sure to use according to the statement recorded by the use of methods to operate. Please do not violate particular attention to the matter reminded to use.
- ▶ Please respect this statement recorded by the note. When consumers in contravention of this statement recorded note of the operation, I am afraid our company could not shoulder any responsibility.
- ▶ Products are defective, the Company will be responsible for free to amend the flaws, or to the same flawless product or its equivalent products in exchange. However, the Company does not assume based on the requirements of the flaw and loss responsibility.
- ▶ The Company reserves the right to retain without notice to users of the cases, the product of hardware / software (version upgrade) is with the right to edit.

Declaration

This product meet different telecommunication regulation.

Warranty

The warranty time is within one year from purchased date. The warranty scope are used in normal situation and none vandalism. (Some function harmful out of warranty scope and Vandalism are Un-warranty).

Configuration guide

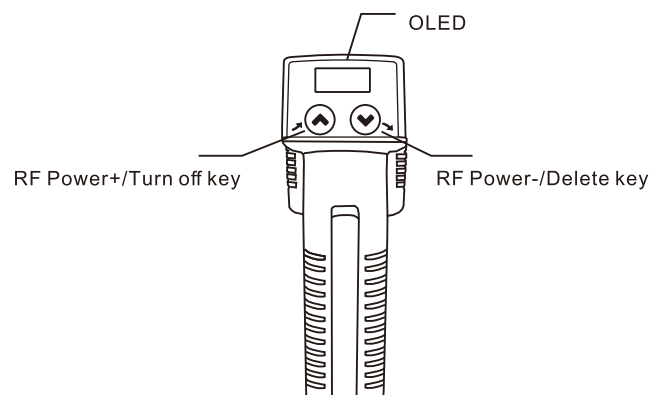
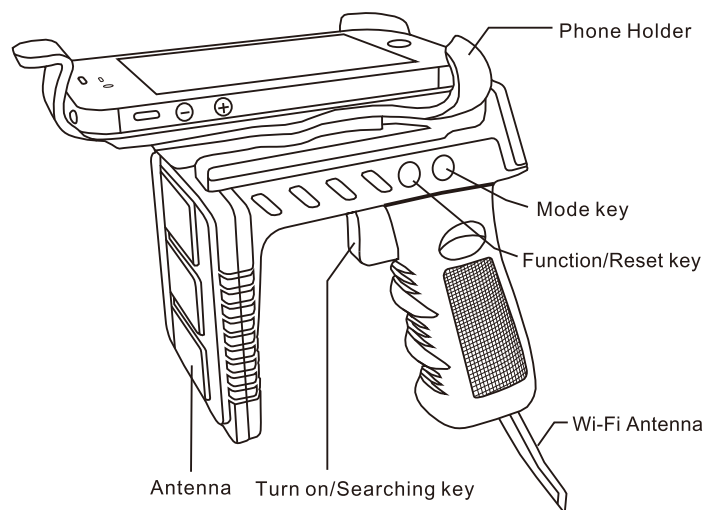

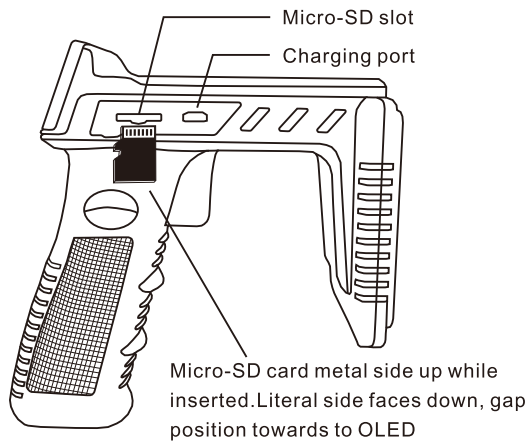

Specification

Working Frequency : American standard (902~928MHz),
China standard (920~925MHz)
RF power : 1W (made by customization)
Passive tags identification distance : 7 meters (Max)
Tag reading time : Operating time per one label <6ms
Modulation mode : ASK or PR-ASK
Protocol : ISO18000-6C (EPC GEN2), ISO18000-6A/B
Power : Li-ion battery 3000 mAh
Charging power : DC 5V 1A
Display: Monochrome light blue 96 x 39 Pixels OEL
Antenna : Microstrip Ceramics Antenna
Polarization : RHCP
Storage device: MicroSD card (Maximum 32G)
Wireless Interface : Serial Wi-Fi, Bluetooth SPP 2.1
Storage temperature : -40°C~+70°C
Dimensions : 138*138*72mm
Weight: 270g (including battery)

3 4

Operating instruction

Turn on/off

By using Ws-LOOKID(Handheld RFID Reader). Press the button "turn on/searching" to turn on the device (Figure 1).

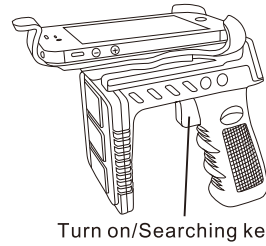

Figure 1

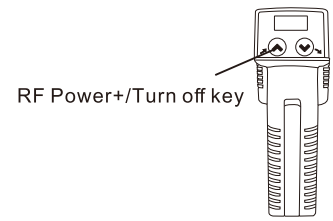

Figure 2

Immediately turn off by holding the button 3 seconds. By holding the button 5 seconds shows "Power off" and illustrates the mode in use at present. Automatically turn off to save the energy when device idled exceed 5 minutes (Figure 2).

OLED display

OLED display functions content as the figure (figure 3).

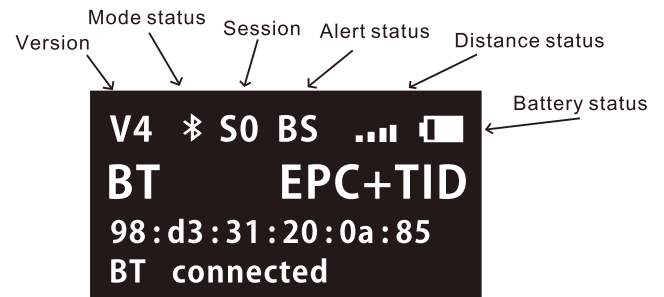

Figure 3

Switch mode

There are 3 different modes for user to switch, Micro SD card mode, Bluetooth mode and Wi-Fi mode (Figure 4). Please pull the antenna out when you choose Wi-Fi mode (Figure 5).

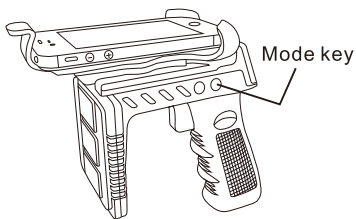

Figure 4

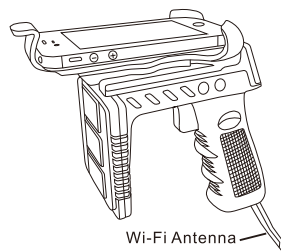

Figure 5

Bluetooth mode

When you switch to the Bluetooth mode, the reader will transmit the tag's information to the other devices via Bluetooth, please refer to the following process of connection:

1. Connect to the receiver's Bluetooth (PC or smartphone).
2. Searching.
3. Connect to Bluetooth named "Handset RFID Reader xxxxxxxx" (xxx given by Bluetooth device).
4. Password: 6666
5. Connection succeed to transmit the tag's information.

When the reader connects to device, the OLED will show "BT" on top of the screen, "BT" with device name on the middle and "BT-connected" on the bottom (figure 6). If the connection failure, the OLED will not be shown "BT", but will show "BT-disconnect" on the bottom (figure 7).

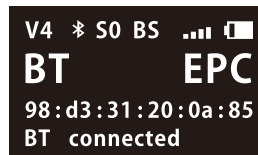

Figure 6

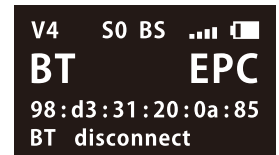

Figure 7

Micro SD mode

The reader will automatically establish a file named "RFID_TAG" and write the information sequentially inside the file when it searching the Tag. While the Micro SD card inserts, the OLED will show "SD inserted" sign (figure 8). If you didn't insert the SD card inside, the OLED will not show SD sign but show "SD unplu99ed" on bottom of the screen (figure9).

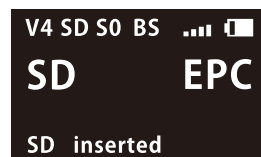

Figure 8



Figure 9

Wi-Fi mode

When you switch to the Wi-Fi mode, the reader will transmit the tag's information to the other devices via Wi-Fi, please refer to the following process of connection:

1. Connect to the receiver's Wi-Fi (PC or smartphone).
2. Configuring your computer to obtain an IP address automatically (Dynamic IP)
3. Search and connect to device named Wi-Fi-socket (Set the internet in default)
4. Open the browser and enter 192.168.1.100 to go into Wi-Fi settings page.

5 6

5. Enter the user name: admin user password:000000.
6. Follow the system construction to set up Wi-Fi functions, our reader provides 3 modes: Ad-hoc (wireless ad hoc network), AP (Access Point) and STA(Station)

When the reader connects to device, the OLED will show “📶” on top of the screen, “Wi-Fi” on the middle and “Wi-Fi connected” on the bottom (figure 10). If the connection failure, the OLED will not be shown “📶”(Figure 11).



Figure 10



Figure 11

WiFi Configuration Process

AP Mode

1. Start handheld reader and switch to WiFi mode (approved WiFi: “wifi-socket”, open network), then find “wifi-socket” network and connected on PC(Figure 12).



Figure12

2. Open browser and enter 192.168.1.100(Figure13), first time login to the WEB server, it requires the default account “admin”, password “000000” to enter the set up page(Figure 14).



Figure13



Figure14

3. In “Wireless Settings” column, the “Work Type” is working mode which select the default AP mode; “SSID” is WiFi device name, it can reserve the default name or define it; the rest category remain default, click “Save” button to save the setting(Figure15).

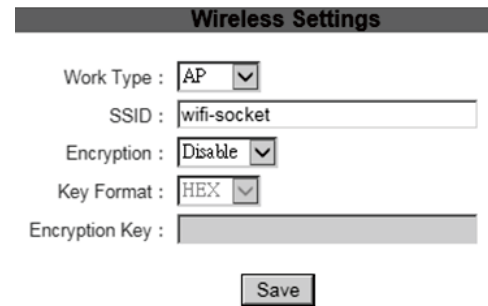

Figure15

4. In “Network Settings” column, to set up IP automatically (Mark check before the “Auto IP Enable”) or by set up IP, “Fixed IP Address” enter IP address; Subnet Mask” enter subnet mask; the rest category remain default, click “Save” button to save the setting (Figure 16).

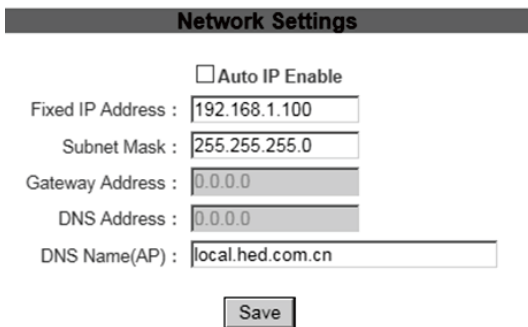

Figure16

5. In “Auto Mode Settings” column, mark a check (default) before the “Auto Mode Enable”, “Protocol” is communication protocol, choose “TCP” (default) or “UDP” to communicate; “C/S Mode” is working mode AP mode reserve preset; “Tcp Link TimeOut is equipment standby time disconnection, the “port number” can be set up by your preference (like 50000), click “Save” button to save the setting (Figure17).

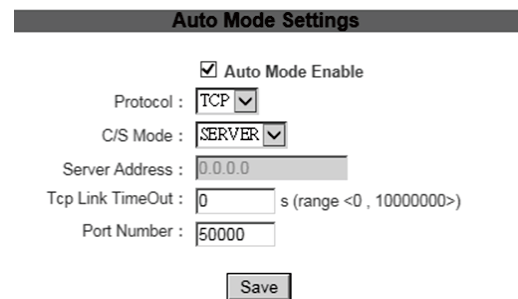

Figure17

6. Click “System”, click “Restart System” button (Figure18), when it appears “for about 10s”, the set up complete(Figure19).

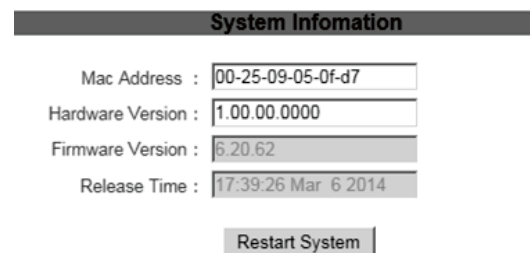

Figure18

Wifi module is restarting, please waiting (for about 10s)

Figure19

7. Set up complete open “CMD” window on PC, enter “ping 192.168.1.100” commend to correspond with handheld reader, as Figure 20 shows the data transmitted has set up complete(Figure 20).



Figure 20

Sta Mode

1. Start handheld reader, and switch to WiFi mode (default WiFi name is "wifi-socket", open network), then find "wifi-socket" network on PC to connect(Figure 21).



Figure 21

2. Open browser and enter 192.168.1.100(Figure 22), first time login to the WEB server, it requires the default account "admin", password "000000" to enter the set up page(Figure 23).

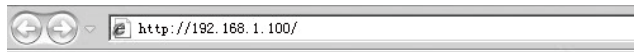

Figure 22



Figure 23

3. In "Wireless Settings" column, the "Work Type" is working mode which select the Sta mode; "SSID" is WiFi device name, revise current connected wireless network (like RF1); "Encryption Key" is WiFi password, enter the current connected wireless network password (like 12345ccccc); the rest remain default, click "Save" button to save the setting(Figure 24).



Figure 24

4. In "Network Settings" column, to set up IP automatically (Mark check before the "Auto IP Enable") or by set up IP, "Fixed IP Address" enter IP address; "Subnet Mask" enter subnet mask; the rest category remain default, click "Save" button to save the setting (Figure 25).

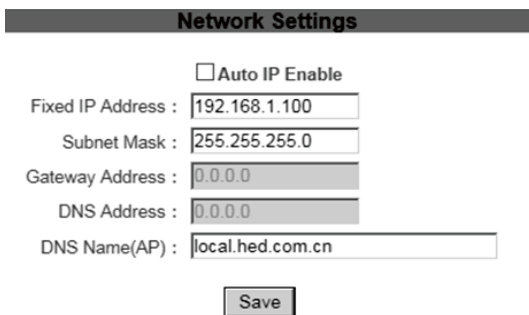

Figure 25

Set up two ways in Sta mode

A. VIA SERVER

5. In "Auto Mode Settings" column, mark a check (default) before the "Auto Mode Enable", "Protocol" is communication protocol, choose "TCP" (default) or "UDP" to communicate; "C/S Mode" is working mode, choose "SERVER" (when you in SERVER mode) or "CLIENT" mode; "Tcp Link TimeOut" is equipment standby time disconnection, the "port number" can be set up by your preference (like 50000), click "Save" button to save the setting(Figure 26).

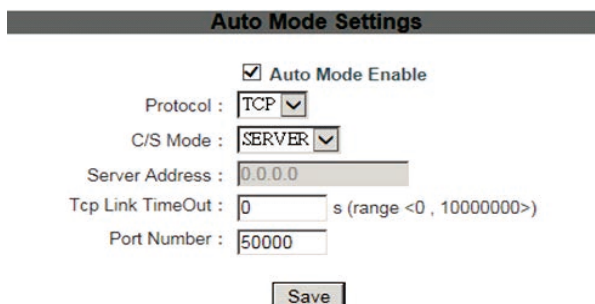

Figure 26

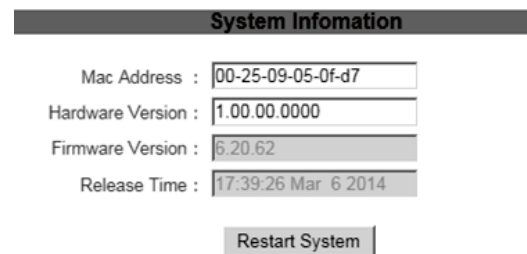

Figure 27

Wifi module is restarting, please waiting (for about 10s)

Figure 28

7. When set up complete, PC connect the network of handheld reader (like the RF1 network), click connect RF1 network(Figure 29).



Figure 29

8. Set up complete open "CMD" window on PC, enter "ping 192.168.1.100" command to correspond with handheld reader, as Figure 30 shows the data transmitted has set up complete(Figure 30).

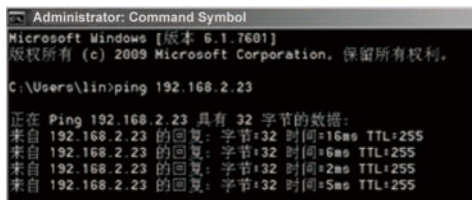

Figure 30

B. VIA CLIENT

9. In "Auto Mode Settings" column, mark a check (default) before the "Auto Mode Enable", "Protocol" is communication protocol, choose "TCP" (default) or "UDP" to communicate; "C/S Mode" is working mode, choose "SERVER" (when you in SERVER mode) or "CLIENT" mode; "Tcp Link TimeOut" is equipment standby time disconnection, the "port number" can be set up by your preference (like 50000), click "Save" button to save the setting (Figure 31).

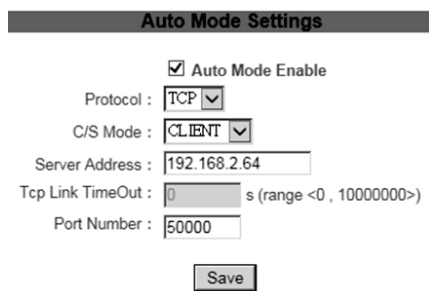

Figure 31

10. Click "System", click "Restart System" button (Figure 32), when it appears "for about 10s", the set up complete (Figure 33).

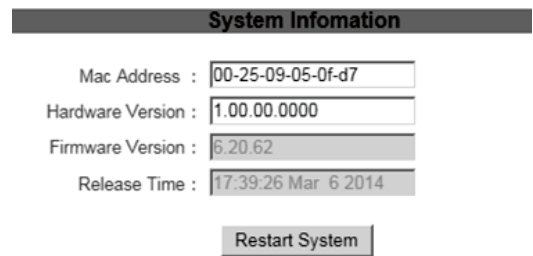

Figure 32

Wifi module is restarting, please waiting (for about 10s)

Figure 33

11. When set up complete, PC connect the network of handheld reader (like the RF1 network), click connect RF1 network (Figure 34).

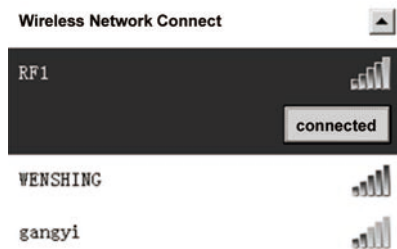

Figure 34

12. Set up complete open "CMD" window on PC, enter "ping 192.168.1.100" command to correspond with handheld reader, as Figure 35 shows the data transmitted has set up complete (Figure 35).

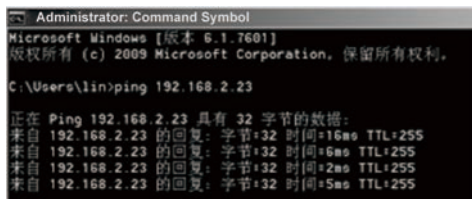

Figure 35

Reset the Wi-Fi settings

In Wi-Fi mode to reset the settings by holding "Function/reset" button until second prompt, Wi-Fi setting will automatically reset to the initial settings, meanwhile the OLED will show "Init Wi-Fi" (Figure 36, 37).

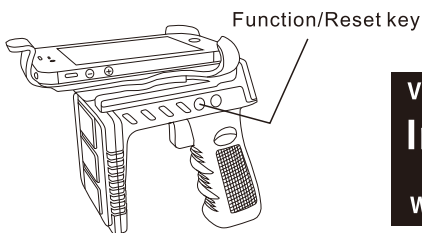

Figure 36



Figure 37

Adjust reading range

According to the different tag and environment, user can adjust the searching range by pressing RF power button.

RF power + : RF power goes up by pressing the button each time until reach to full signal (Figure 38, 39).

RF Power+/Turn off key



Figure 38



Figure 39

RF power - : RF power goes down by pressing the button each time until reach to lowest signal (Figure 40, 41).

RF Power-/Delete key



Figure 40

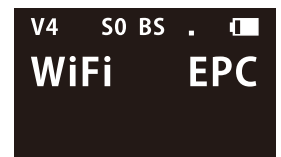

Figure 41

Switch the function

There are 3 ways of prompt to switch, Buzzer, Vibration, Buzzer with Vibration. Switched by pressing function buttons (Figure 42).

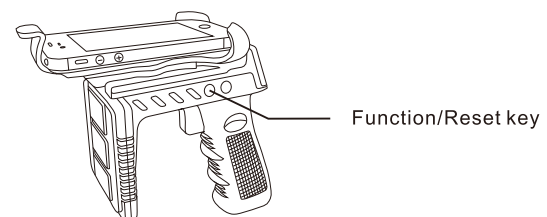

Figure 42

When you switch to the vibration prompt, the OLED will show "S" sign on top of the screen. The vibration will be prompted by press button and read the tag each time (Figure 43).

When you switch to the buzzer prompt, the OLED will show "B" sign on top of the screen. The buzzer sound "didi" will be prompted by press button and read the tag each time (Figure 44).

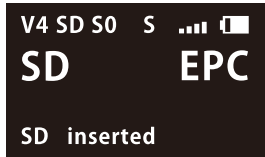

Figure 43



Figure 44

When you switch to the buzzer with vibration prompt, the OLED will show "BS" sign on top of the screen. The buzzer sound "didi" & vibration will be prompted by pressing button and read the tag each time (Figure 45).



Figure 45



Figure 46

Delete micro SD file

In Micro SD mode to delete the data in card by holding delete button until second prompt, the content of RFID_TAG.TXT will be eliminated meanwhile the OLED will show "Clear SD file" on bottom of the screen (Figure 46, 47).

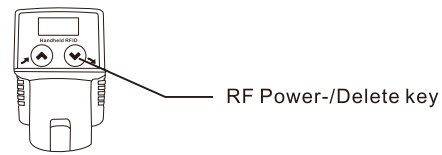
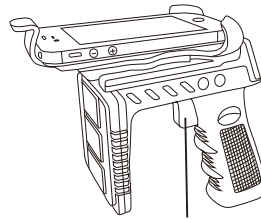

Figure 47

Searching

By holding "turn on/search" button (figure 48) to keep searching tags in area, and transmit the tag's information to device by chosen mode (Figure 49, 50).



Turn on/Searching key
Figure 48

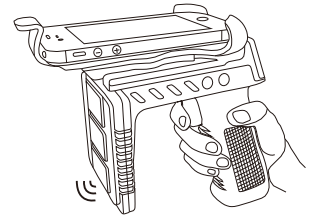
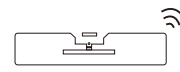

Figure 49



TAG
Figure 50

By using our reader to search the tag, OLED will show "Search 00" (Figure 51). When the reader read the tag, OLED shows "Search 01" on the screen, "01" means reader has searching one tag at present (Only available in SD card mode, "01" can not be shown on the other modes). The tag's EPC numbers will show on the bottom of the screen, the numbers will be shown by turns if the reader reads 2 tags and above (Figure 52).

19 20



Figure 51

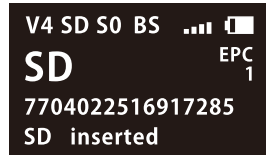

Figure 52

Format of reading data

This product provides 3 different ways of data format for outputting, EPC, TID and EPC+TID. By holding "mode" button until the second prompt appears then release the button and enter the setting menu. To switch the data format by pressing "power+" or "power-" (Figure 53, 54, 55, 56).

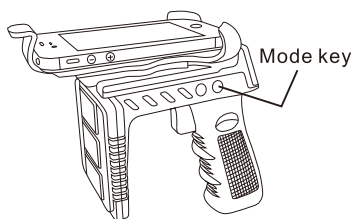

Figure 53



Figure 54



Figure 55



Figure 56

Press the "mode" button to enter the reserve menu and then press "power+" save the setting, "power-" non-save the setting (Figure 57, 58).

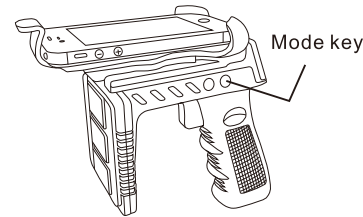

Figure 57

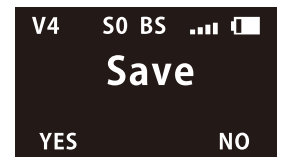

Figure 58

Searching mode

This product has 5 searching modes: S0, S1, S2, S3 and S4
 S0= Non-stop reading
 S1= Mass tags reading
 S2=Special purpose
 S3=Special purpose
 S4=Closest tag reading only

By holding "mode" button until second prompt appears then release the button. Enter the setting menu then press "function" button to enter the searching mode menu, each press "power+" or "power-" to switch the searching mode (Figure 59, 60).

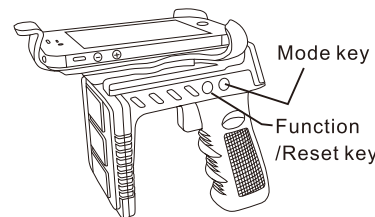

Figure 59

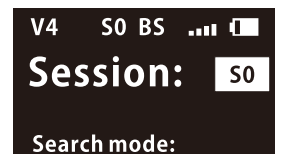

Figure 60

21 22

Press the "mode" button to enter the reserve menu and then press "power+" save the setting, "power-" non-save the setting (Figure 61,62).

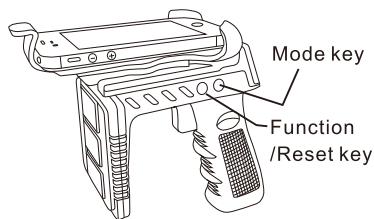

Figure 61

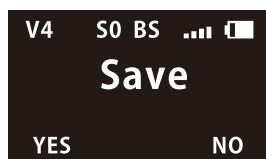

Figure 62

Install holder

The holder of the reader is detachable, remove the lid before installing (Figure 63), then put the holder into the hole on the reader and screw the nuts in tight (Figure 64).

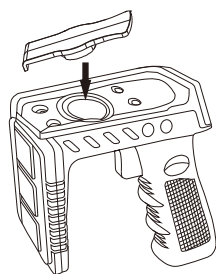

Figure 63

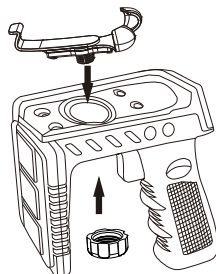

Figure 64

CE Caution Note (European Union)

Symbol of **CE** it accords with EMC regulation (89/336 / EEC) to represent this device, and the low-voltage regulation of European Union (73/23/EEC). It represents to follow the following standard regulations of European Union (The bracket is a reciprocal international standard reciprocal international standard and regulation).

- ▶ EN 60950/A11: 1997/(IEC 60950/A4: 1996),The ones that includes information science and technology of apparatus of e-commerce safe.
- ▶ EN 55024: 1998 (IEC 1000-4-2, 1000-4-3, 1000-4-4, 1000-4-5, 1000-4-6, 1000-4-8, 1000-4-11) -' scientific and technological apparatus of information - The characteristic of interfere avoided - Restrain and test method
- ▶ Chapter 2 -Static release (ESD) Demand
- ▶ Chapter 3 -Radiate the static field demand
- ▶ Chapter 4 -The electron is transmitted / produced and washed (EFT) fast Demand.
- ▶ Chapter 5 -surge demand
- ▶ Chapter 6 -Resistance demand caused in field of wireless frequency.
- ▶ Chapter 8 -Magnetic field demand of electric frequency.
- ▶ Chapter 11 -Shortly cut off the demand of making a variation with the voltage transiently under the voltage.

EN 55022:1998/(CISPR 22:1997) ,Class B, "To assess information scientific and technological apparatus wireless restriction and way of interfering with the characteristic."

Administrative Regulations on the Low Power Radio Waves Radiated Devices

Article 12

Without permission granted by the DGT, any company, enterprise, or user is not allowed to change frequency, enhance transmitting power or alter original characteristic as well as performance to a approved low power radio-frequency devices.

Article 14

The low power radio-frequency devices shall not influence aircraft security and interfere legal communications; If found, the user shall cease operating immediately until no interference is achieved.

The said legal communications means radio communications is operated in compliance with the Telecommunications Act.

The low power radio-frequency devices must be susceptible with the interference from legal communications or ISM radio wave radiated devices.

FCC Consistent Declaration (U.S.A. Only)

Attention: FCC rule regulation, modified and changed must allowed by WENSHING Electronics company, otherwise that would make you operate this apparatus invalid. This apparatus adopted test, according to chapter 15 that FCC regulation, accord with Class B digital restrictions of device. These limits are designed to provide reasonable protection, avoid to having harmful interference at home's environment.

This device may have radiated wireless frequency energy. If don't allow the instruction manual, then may will interfere wireless communication. However, there is no any way to guarantee, it will not be interfered in particular installed. If this device really causes harmful interference, (It could be confirmed by turning on or off this device.) Advise you to try to use the following ways modifying the interference situation.

- ▶ Relocation receiving antenna or altering its direction.
- ▶ Increase the distance between device and receiver.
- ▶ Please connect this device to the outlet in the circuit different from the receiver.
- ▶ The following manuals is published by Federal Communications Commission, they must be helpful to all users.
- ▶ How to Identify and Resolve Radio-TV Interference Problems. (This manual can be obtained by relevant departments of publication of the U.S. government.)
- ▶ Government Printing Office, Washington D.C., 20402. Stock No. 004-00398-5

Notice: The changes or modifications not expressly approved by the party responsible for compliance could void the user's authority to operate the equipment.

IMPORTANT NOTE: To comply with the FCC RF exposure compliance requirements, no change to the antenna or the device is permitted. Any change to the antenna or the device could result in the device exceeding the RF exposure requirements and void user's authority to operate the device.

Version History

| Version | Date | Changes |
|---------|-------------|-------------------------|
| V1.00 | May.27.2014 | 1 st Edition |